

Space for Lease Information:

4300 S. I-10 Service Rd.
Metairie, LA 70001

Suite: 109

RSF: 1,413

Comments:

Suite with 5 offices and open
area that can be used for
reception.

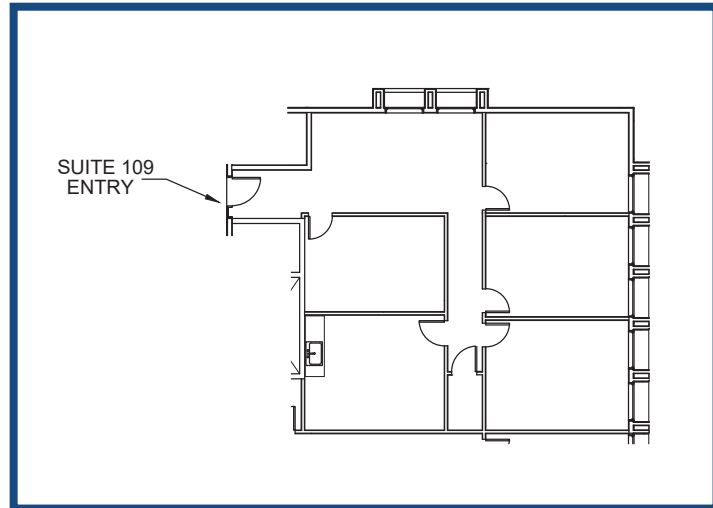

Contact

1st Lake Commercial Properties, Inc.
3925 N. I-10 Service Rd. Suite 130
Metairie, LA 70002
504.455.8644 Fax: 504.885.4941
Licensed in the State of Louisiana

The foregoing is solely for information purposes and is subject to change without notice. Subject to errors, omissions, changes in terms and conditions prior to lease or withdrawal without notice.